

ANCAP TEST & ASSESSMENT PROTOCOL

Far Side Impact
v2.5



2023
2024
2025



PREFACE

During test preparation, vehicle manufacturers are encouraged to liaise with ANCAP and to observe the way the vehicle is set up for testing. Where a vehicle manufacturer feels that a particular aspect should be altered, they should raise this with the ANCAP assessor present at the test, or in writing to the ANCAP Chief Executive Officer if no assessor is present. ANCAP will consider the matter and at their sole discretion give direction to the test facility.

Vehicle manufacturers warrant not to, whether directly or indirectly, interfere with testing and are forbidden from making changes to any aspect that may influence the test, including but not limited to dummy positioning, vehicle setting, laboratory environment etc.

Illustrations in this protocol are reproduced from Euro NCAP publications, and therefore show Euro NCAP markings on left-hand-drive vehicles. Where relevant, the layouts depicted should be adapted to right-hand-drive application.

VERSION

VERSION	PUBLISHED	DETAILS
1.1	February 2019	First ANCAP version of protocol
2.0	July 2019	
2.0.1	July 2020	Changes to reflect delayed introduction of new protocols to 2023
2.1	July 2021	Added s4.2.9 Lower Neck load calculation Added Lap Belt measurement s4.3 Revised dummy head painting (s4.6) Additional measurement point (s4.7.1) Revised scoring colour for red zone (s7.2.2) Limited provision for combined MDB and O2O in official test. (s7.4.2.2)
2.1.1	February 2022	Corrected calculation of My (base of neck) (s4.2.9) Clarified Appendix II – acceleration measurement on Body-In-White
2.2	March 2022	S6.2.1 Added reporting points for sled test Removed reference to MDB Dual Occupancy Test S7.4.2.3 Removed 2020-22.transitional provisions
2.3	January 2023	Clarified spacer requirements (3.2.7) Reference to TB 021 (4.2.9) Clarified deliverables (6.2.1) Clarified calculation method and plots in Appendix II
2.4		No ANCAP version
2.5	April 2024	Virtual testing requirement (from 2026) (s1.2, 1.4) Clarified sled pulse (s4.1.3) Clarified data requirement (s4.2.7) Additional pre-test measurements (s4.7.2) Test identification for films (s5.2) New appendix IV (required channels) New appendix V (dummy measurements) Updated WorldSID definition (s4.2.1) Updated injury criteria (Lower Neck Extension and DAMAGE)(s7.3.1)

DISCLAIMER

ANCAP has taken all reasonable care to ensure that the information published in this protocol is accurate and reflects the current technical decisions taken by the organisation. In the event this protocol contains an error or inaccuracy, ANCAP reserves the right to make corrections and determine the assessment and subsequent result of the affected requirement(s).

COPYRIGHT

Copyright 2024. This work is the intellectual property of ANCAP with certain content reproduced with the permission of Euro NCAP. A license is granted for this material to be shared for non-commercial, educational purposes, provided this copyright statement appears on the reproduced materials and notice is given that the copying is by permission of ANCAP. To disseminate otherwise or to republish will be considered a breach of intellectual property rights.

AUSTRALASIAN NEW CAR ASSESSMENT PROGRAM (ANCAP) TESTING AND ASSESSMENT PROTOCOL – Far Side Impact

CONTENTS

1	INTRODUCTION	1
2	PREREQUISITES	1
3	HARDWARE SETUP	2
4	SLED TEST PROGRAMME	6
5	PHOTOGRAPHIC RECORD	12
6	DATA PROCESSING AND REPORTING	18
7	FAR SIDE OCCUPANT ASSESSMENTS	19
	Appendix I	24
	Appendix II	26
	Appendix III	28
	Appendix IV	33
	Appendix V	35

1 INTRODUCTION

- 1.1 This protocol details the assessments to be performed in far side occupant protection that contribute to the side impact part of the adult occupant protection rating.
- 1.2 From 2026 onwards, virtual test data will be required by ANCAP. It will then be necessary to use this protocol in combination with the VTC Simulation and Assessment Protocol.
- 1.3 Far side protection is assessed using two sled tests that are representative of MDB and Oblique Pole test configurations. In addition, data from full-scale testing is required to demonstrate head protection countermeasures for occupant-to-occupant interaction.
- 1.4 The far side occupant sled test data will be supplied to ANCAP by the vehicle manufacturer prior to the official tests. From 2026 onwards, the simulation data must be supplied in advance of the physical testing. Refer to the VTC Simulation and Assessment Protocol for further details.
- 1.5 Far side test data will only be accepted in the form of physical sled tests; full scale tests and CAE data will not be accepted.
- 1.6 Vehicles with three positions on the front row will be assessed in the outboard positions, 1 and 3, only.

2 PREREQUISITES

- 2.1 In the official MDB and pole impacts, the structural performance of the door; it's attachments to the body, the roof/cant rail and sill must be structurally 'stable' to provide confidence in the position intrusion lines. Detachment of door latches/hinges, fully opened doors or structural failures of the roof/cant rail and sill will preclude the acceptance of far side assessment data.
- 2.2 Any of the following post-test conditions will disqualify the vehicle from any rewards in far side occupant protection.
 - 2.2.1 Where the total score of the MDB and pole impacts is below 10.0 points (out of 12).
 - 2.2.2 Restraint system failures in either the MDB or pole impacts that are intended for far side occupant protection. For example, incorrect deployment of centre (occupant to occupant) airbags.

3 HARDWARE SETUP

3.1 General

- 3.1.1 An acceleration-based sled rig is to be used along with a 'body in white' (BIW) of the car model being assessed.
- 3.1.2 Deceleration sleds will be permitted provided that clear evidence is given showing that the dummy remains in the initial position and that the duration of the pulse is as long as the vehicle pulse observed in the official tests.
- 3.1.3 The BIW shall be mounted with the centreline at $75^{\circ} \pm 3^{\circ}$ towards the direction of travel.
- 3.1.4 A BIW that is of a pre-production state will be accepted if it is shown to be representative of series production and that any differences have no influence on the far side assessment.
- 3.1.5 All features which may influence occupant kinematics and protection must be installed in the BIW.
- 3.1.6 The BIW may be from either a right or left-hand drive vehicle.
- 3.1.7 For the purpose of this assessment, the 'far side occupant' is on the driver's side of the vehicle which is also the non-struck side. The struck side is the passenger's side of the vehicle.
- 3.1.8 One WorldSID 50th male dummy will be seated on the far side of the vehicle.
- 3.1.9 The assessment shall be performed on the specification of equipment fitted to the bestselling variant. This includes, but is not limited to, the transmission, front seats, restraints and interior trim/centre console.
- 3.1.10 The seats of the bestselling variant (as per MDB and pole impacts) will be used in the BIW.

3.2 Body preparation

- 3.2.1 The bodyshell shall be mounted on the sled such that there will be no permanent deformation of the body or its mounts during the tests.
- 3.2.2 Struck side intrusion will not be replicated on the BIW.
- 3.2.3 Driver and/or passenger doors will not be required.
- 3.2.4 Structures forwards of the A-pillar and windscreen cowl and rearward of the B-pillar may be removed from the BIW as long as the stability is not compromised
- 3.2.5 Reinforcement of the BIW is recommended but not required provided the BIW is sufficiently stable. The following areas are suggested:
 - Pillars and cross members
 - Seatbelt mountings (D-loop & Retractor)
 - Driver's seat plinth
 - Roof
- 3.2.6 To ensure a clear view on dummy kinematics, vehicles with removable roofs, panels or movable sunshine roofs shall be tested without the roof or with them in the open position. The windscreen shall be removed and sufficient reinforcement around the frame/periphery shall be provided.

Where there is a fixed roof above the front row seats, it shall be cut away between

the cant rails and rearwards of the windscreen surround. Reinforcement should subsequently be applied laterally across the BIW.

- 3.2.7 Sufficient spacers shall be fitted in the gaps between the struck side (B-pillar or other structure) and passenger seat frame, the passenger seat frame and centre console to stabilise the front passenger seat. This represents the behaviour of the struck side seat and centre console due to crash induced intrusion and deformation. The spacer shall support the full height of the centre console but does not need to be made from a single piece of foam. It will be necessary to cut the seat cover and foam to access the frame. An example how this can be done is shown in the picture below.

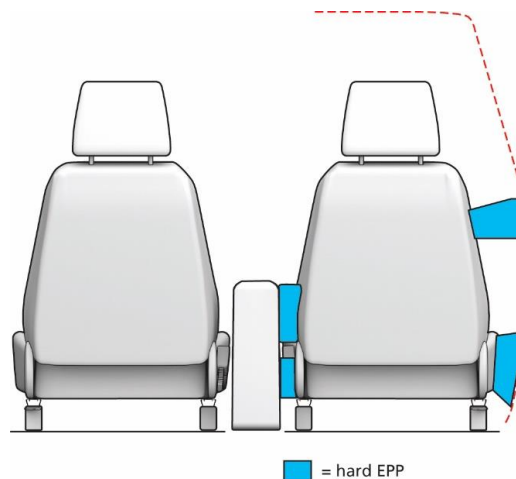

Figure 1: Seat spacers viewed from rear

- 3.2.8 The spacers shall have the stiffness characteristics from expanded polypropylene (EPP60) or stiffer with compression properties of about 340KPa for 25% of compression (determined according to ISO 844).

- 3.2.9 Interior components required for testing will include, but are not limited to:

- Driver and passenger front seats.
- Full tunnel/centre console components consisting of the full tunnel trim, hand brake assembly, gear lever assembly and storage compartments.
- Full facia assembly consisting of the facia, steering column and steering wheel. Infotainment systems may be omitted if appropriate.
- Seat belt/pretensioner and anchorage attachments.
- Struck side internal door trim assembly (if doors installed).

- 3.2.10 If fitted, the struck side door trim shall be painted white (or similar) to contrast with the passenger's seat.

- 3.2.11 The head restraint on the unoccupied seat may be removed in order to get a better view of the grid board and excursion lines.

3.3 Active restraints

- 3.3.1 Active restraint systems shall be standard equipment and identical to those used in the ANCAP impact tests.

- 3.3.2 Pretensioners must be triggered if the firing strategy is such that they are triggered in the side and pole impact tests.

3.3.3 Triggering of pretensioners will be accepted on the sled if the difference in deployment time from the official tests is no greater than +/-2ms.

Where the difference is greater than 2ms, data must be supplied showing that this did not affect the result.

3.3.4 Triggering of other active restraints, such as the side curtain and seat mounted airbags, will not be permitted unless it can be shown that these systems have been designed as a countermeasure intended to lower the risk of far side occupant injury. For example, a head curtain airbag that extends beneath the door level, or a seat mounted airbag that can remain sufficiently inflated for the required length of time to limit occupant excursion.

3.4 Vehicle markings

3.4.1 A chequered or similar grid measuring 50x50mm shall be rigidly mounted to the BIW directly behind, but not attached to the front seats in a way that does not result in interference during the test.

3.4.2 All markings must be extended onto the chequered grid board positioned behind the front seats, the vehicle roof and fascia.

3.4.3 Four vertical and parallel excursion lines will be marked in the BIW for both sled test scenarios. The most inboard edge of each line shall be used as the excursion limit.

- **Maximum intrusion line from MDB and Pole tests (red)**

This line is marking the maximum post-test intruding point of the interior door panel from MDB (60km/h) and 75° pole impacts respectively. The method to determine the maximum deformation is detailed in Appendix I. Peak intrusion values will be compared to those observed in the official tests. The OEM shall provide details of the measurement point used for establishing the intrusion lines. Where the red line is further inboard than any of the other excursion lines, those lines will not be marked on the BIW.

- **Head excursion performance limit (orange)**

Struck side seat centreline (pre-test, without intrusion)

- **Head excursion performance limit (yellow)**

125mm inboard of the struck side seat centreline

- **Occupant interaction limit (green)**

250mm inboard from the struck side seat centreline

3.4.4 In addition to the excursion lines, the vehicle centreline shall be marked in blue.

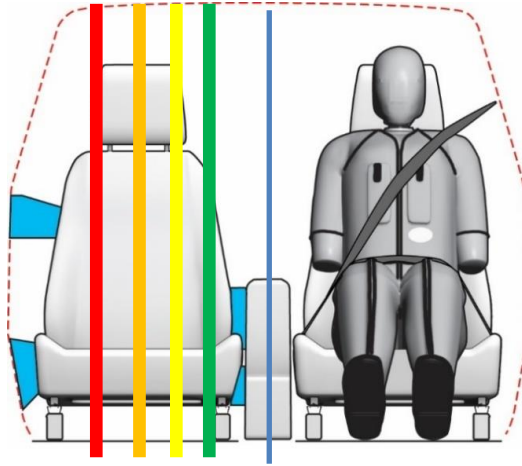

Figure 2: Vehicle markings

4 SLED TEST PROGRAMME

4.1 Sled Acceleration Pulses

4.1.1 Two sled tests are required for the evaluation of far side occupant excursion.

4.1.1.1 One test shall be performed using a representative 60km/h MDB to car non-struck side B-pillar pulse

4.1.1.2 One test shall be performed using a representative 32km/h 75° pole test non-struck side B-pillar pulse.

4.1.2 All pulses shall be from the non-struck side B-pillar base and filtered at CFC60.

4.1.3 The sled pulse shall be a scaled B-pillar pulse as measured in the MDB test and pole test due to the angled test sled set-up. To ensure a similar B-pillar between the full scale and sled tests the following scaling is applied:

$$A_{X,SLED} = A_{Y,VEHICLE(MDB)} \times 1.035$$

$$A_{X,SLED} = A_{Y,VEHICLE(POLE)} \times 1.035$$

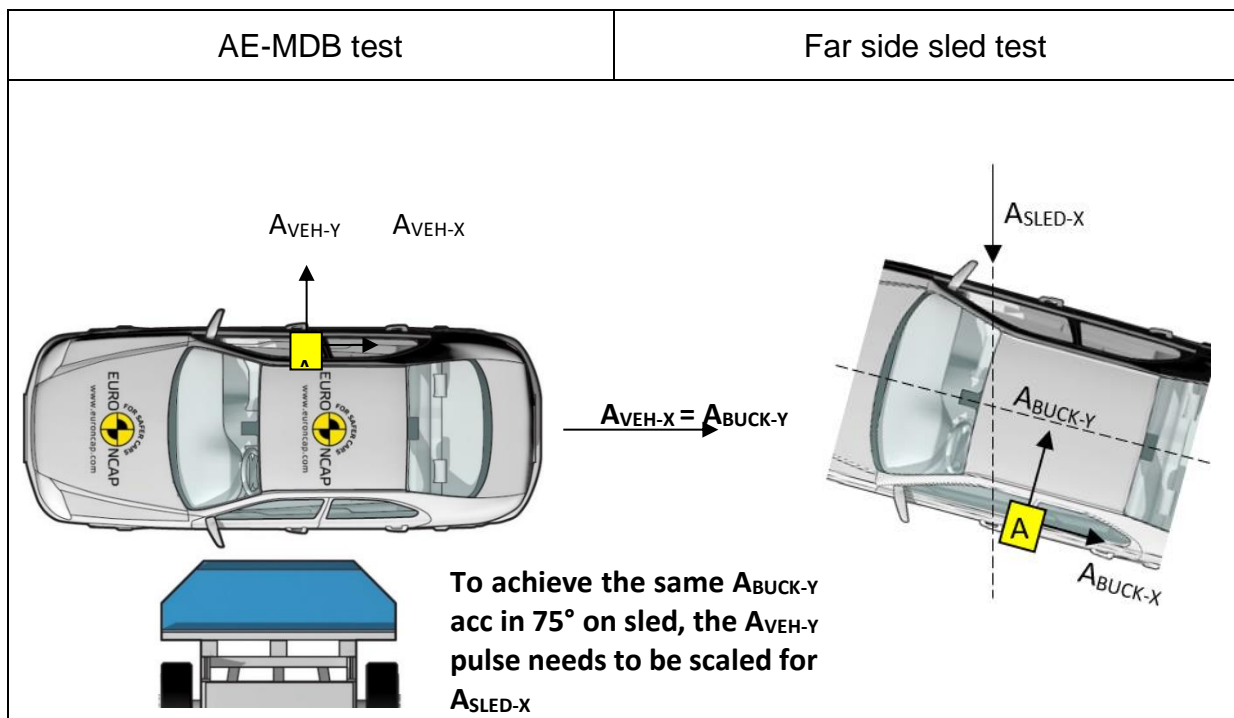

4.1.4 The OEM shall specify the accelerometer location to be used in the official tests to ensure similar positioning between tests.

4.1.5 In house test vehicle variants may differ slightly from the official model tested by ANCAP e.g. engine etc. This is so that testing can be performed in advance of the official ANCAP tests.

4.1.6 The suitability of the correlation between the vehicle and sled pulses will be checked according to the method detailed in Appendix II.

4.2 Dummy and instrumentation

4.2.1 A WorldSID 50th percentile male test dummy shall be used in the front driver's position. It shall conform to the specification detailed in ISO 15830 parts 1-4:2013 &

part 5:2018. Note: From 1st January 2026, ISO 15830 parts 1-4:2022 & part 5:2018 shall be applied.

- 4.2.2 The WorldSID shall be equipped with the half arm assembly on both sides.
- 4.2.3 The dummy shall be clothed in a sleeveless suit or a modified version of the sleeved suit with sleeves removed.
- 4.2.4 The dummy shall have a stabilised temperature in the range of 20.6°C to 22.2°C. A copy of the temperature readings is to be supplied as part of the standard output of the test.
- 4.2.5 A stabilised temperature shall be obtained by soaking the dummy in temperatures that are within the range specified above for at least 1 hour prior to the test.
- 4.2.6 Measure the temperature of the dummy for at least 5 hours before test at intervals not exceeding 10 minutes and not exceeding 5 minutes before test.
- 4.2.7 Data processing shall be in accordance with Euro NCAP Technical Bulletin 021. Appendix IV details all channels required, both measured from hardware test and calculated.
- 4.2.8 The WorldSID shall be instrumented on the struck side to record the channels listed below. Additional channels may be recorded. In-dummy data acquisition system is recommended and in case of 45 or more channels it is required.
- 4.2.9 All lower neck load data is to be supplied, lower neck Mx and My moments shall be corrected according to the correction factor in SAE J1733, detailed in Euro NCAP Technical Bulletin TB 021.

Location	Parameter	Minimum amplitude	Channel count
Head	Linear acceleration, Ax, Ay, Az	250g	3
	Angular velocity, ω_x , ω_y , ω_z	4000deg/sec	3
Upper neck	Forces and moments Fx, Fy, Fz, Mx, My, Mz	5kN, 300Nm	6
Lower neck	Forces and moments Fx, Fy, Fz, Mx, My, Mz	5kN, 300Nm	6
Shoulder – Joint	Forces, Fx, Fy, Fz	8kN	3
Shoulder – Rib	Displacement & rotation	100mm	2
Thorax - Upper rib	Displacement & rotation	100mm	2
Thorax - Mid rib	Displacement & rotation	100mm	2
Thorax - Lower rib	Displacement & rotation	100mm	2
Thoracic temperature	Temperature	30°C	1
Abdomen - Upper rib	Displacement & rotation	100mm	2
Abdomen - Lower rib	Displacement & rotation	100mm	2
Spine - T12	Acceleration, Ax, Ay, Az	200g	3

	Forces $F_x, F_y, F_z,$	5kN	3
	Moments, M_x, M_y, M_z	300Nm	3
Pelvis	Acceleration, A_x, A_y, A_z	200g	3
	Pubic force	5kN	1
	Total Channels		47

4.3 Sled Instrumentation

Location	Parameter	Minimum Amplitude	No of channels
B-Pillar non-struck side (BIW coordinates)	Accelerations, A_x, A_y	150g	2
Sled	Accelerations, A_x	150g	1
Driver Seatbelt Shoulder and Lap* Sections	Force, $F_{diagonal}, F_{lap}$	16kN	2
	Total vehicle channels		5

* Care must be taken to position the lap belt transducer outboard of the dummy so that it does not interfere with the dummy/interior during the impact.

4.4 Passenger compartment adjustments

4.4.1 Passenger compartment adjustments used in the BIW will be as per the relevant passenger compartment adjustments detailed in the MDB side impact test protocol (where relevant).

4.4.2 The driver and passenger seat fore/aft and seat back angles will be positioned identically. Where a vehicle has different seat travel between the driver and passenger side, the passenger seat travel will be positioned as close as possible to that of the driver and the seat back angle will also be the same as that of the driver.

4.4.3 Arm rests

4.4.3.1 Any arm-rests or centre console compartments shall be positioned to limit interaction with the dummy and maximise lateral excursion. See Appendix III.

4.4.3.2 Vehicles equipped with adjustable arm-rests on the seat back will have them positioned in the 'not in use' 'up-folded' position aligned with the seat back.

4.4.3.3 Vehicles equipped with adjustable arm rests as part of the centre console will have them positioned fully down and fully retracted.

4.4.3.4 The lid of any arm rest/storage compartment shall be closed.

4.4.3.5 Parts that can be removed from the centre console assembly must be present for the test provided they are equipped on the specification of vehicle tested by ANCAP.

4.4.4 The parking brake shall be in the disengaged position and the gear lever in D or in a gear position.

4.5 Driver dummy positioning

4.5.1 The dummy shall be installed on the driver's seat (non-struck side) in accordance with the H-point manikin and dummy positioning procedures detailed in the MDB side impact test protocol.

4.6 Dummy painting & Markings

4.6.1 The dummy shall have masking tape placed on the areas to be painted using the sizes detailed below. The tape should be completely covered with the following coloured paints. The paint should be applied close to the time of the test to ensure that the paint will still be wet on impact.

Driver

Head inboard (Paint tape outline)		Blue, Red & Green
Head CoG inboard (circle Ø40mm)		Orange
Head top along mid sagittal plane		Green & Yellow
Shoulder	Arm	Blue
2nd Thorax	Rib	Green
3rd Thorax	Rib	Red
1st Abdomen	Rib	Blue
2nd Abdomen	Rib	Green
Pelvis		Orange

NOTE: The tape should be completely covered with the coloured paints specified, except for the driver head which should have only the outer edge of the tape painted.

Tape Sizes:

Head = 100mm square, centreline of head with lower edge at CoG.

Head = 200mm x 20mm strip, centre located at head CoG

Arm = 25mm x 150mm, starting at bottom edge of shoulder fixing hole.

Ribs = 25mm x 150mm strip, starting at the rearmost point at seat back.

Pelvis = 50mm x 100mm, centred on hip joint point.



Figure 3: Dummy head painting

4.6.2 The dummy shall have two markers at the front of the dummy head for video analysis. They will be positioned on the head front mould split line at:

- Centre of Gravity
- 100mm below Centre of Gravity

4.7 Pre-test measurements

4.7.1 To ensure repeatability of dummy seating & positioning - take detailed static 3D measurements of dummy, seat belt anchorage points and vehicle interior after the dummy settling and positioning procedures have been carried out.

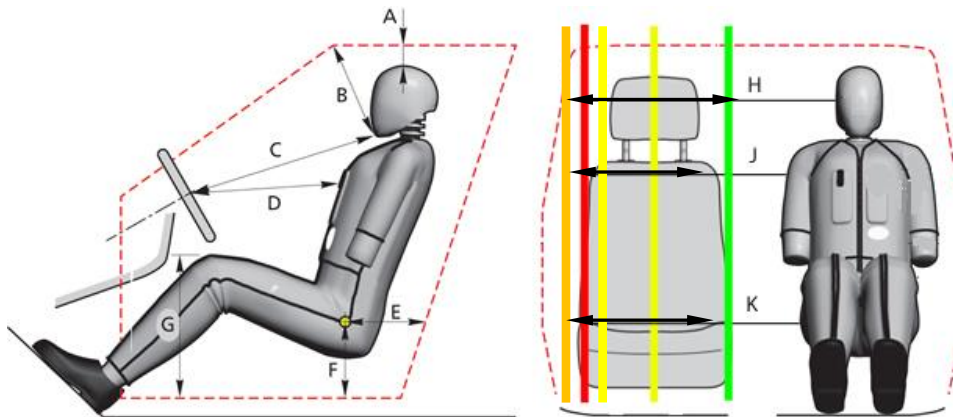

Figure 4: Pre-test measurements

Driver measurements	
A	Not required
B	Chin/windscreen joint
C	Chin/centre of the steering
D*	Thorax strap/centre of the steering wheel
E	Hip-joint point/inside opening of the door (horizontal), manikin and dummy
F	Hip-joint point/inside opening of the door (vertical), manikin and dummy
G	Knee/floor covering (vertical)
H	Head to seat centreline
J	Shoulder to seat centreline
K	Hip-joint point to seat centreline

* Horizontal distance from steering wheel centre

4.7.2 In addition to the measurements specified above, the locations of the WorldSID in the table below shall be taken prior to the physical test tests. These are to be used as a reference for comparison with the initial posture and position of the CAE dummy. A suitable origin for the CMM measurements is needed (e.g. door striker) and shall be specified by the vehicle manufacturer. See Appendix V for further information.

Measurement location		Coordinates		
Head CoG	Head skin outboard marking	X	Y	Z
Head	Tilt angle sensor	1D		
Neck bracket	Corner front	X	Y	Z
Neck bracket	Corner rear	X	Y	Z
Shoulder	Screw centre	X	Y	Z
Arm	Tip of foam centre	X	Y	Z
Arm	Upper arm angle	1D		
Thorax	Tilt angle sensor	1D		
H-point		X	Y	Z
Pelvis	Tilt angle sensor	1D		
Femur	Centreline of clevis	X	Y	Z
Femur	Angle	1D		
Knee	Joint screw centre	X	Y	Z
Ankle	Screw centre	X	Y	Z
Head restraint	Hole	X	Y	Z
Seatback	Angle (OEM location)	1D		
Seatbelt	Upper belt edge at dummy centreline	X	Y	Z

5 PHOTOGRAPHIC RECORD

- 5.1 Insufficient high speed or still photography could result in the data not being accepted by the ANCAP Secretariat.
- 5.2 From 2024 onwards, the relevant test number, supplied by the Euro NCAP Secretariat, must be placed physically on the sled, visible in all videos and referenced in all data files e.g. .mme.
- 5.3 It is essential that the onboard cameras are attached to the sled in a way that minimises relative motion during the test.
- 5.4 Sufficient lighting must also be provided to ensure that the maximum head excursion can be clearly seen on the high-speed film.
- 5.5 High speed film
 - 5.5.1 High speed film, 1000fps minimum, is required for both tests. The following specification shall be used:
 - Format: MP4 or AVI.
 - Codec: H.264, Data/Bit rate: 2 Mbps.
 - Resolution: Native camera resolutions.
 - Frame rate: 1000 fps.
 - Must include burnt in timers
 - 5.5.2 Sled mounted high speed cameras shall be used to record the whole of the relevant scene.
 - 5.5.3 The minimum number of cameras required for each test is five.
 - 5.5.4 Two cameras must be positioned either side of the zone in which the head excursion is anticipated. For example, if the excursion is expected in the orange zone, cameras 2 & 3 will be the minimum required, camera 6 would be placed on the orange line.
 - 5.5.5 Where the camera positions are overlapping, the highest priority regarding camera positioning should be given to camera 1, but camera 2 is still required.

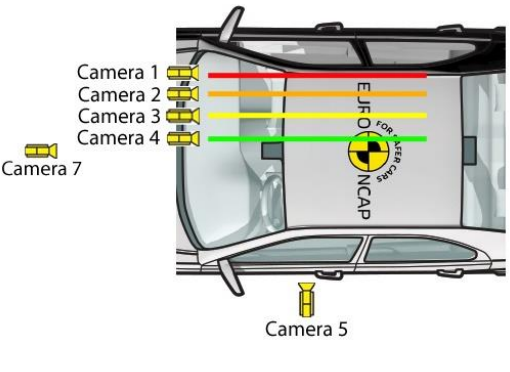
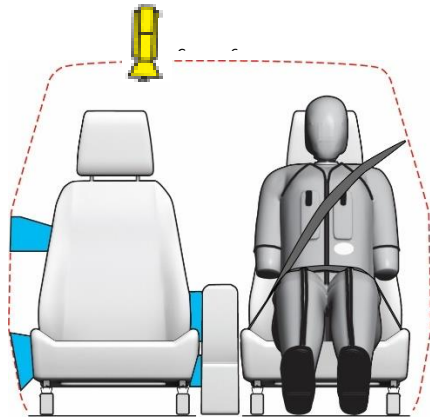
	
<p><u>Onboard camera views:</u></p> <ol style="list-style-type: none"> 1. Front, red line 2. Front, orange line 3. Front, yellow line 4. Front, green line 5. Side, driver pre-test pelvis to head 6. Plan, most outboard head excursion line 	<p><u>Offboard camera views:</u></p> <ol style="list-style-type: none"> 7. Front, parallel to vehicle centreline

<p>Camera: 1</p>

<p>Description: Front view centred to intrusion limit and parallel to vehicle centreline. Frame width: Outboard edge of A-pillar to far side seat centreline. Frame height: Front edge of roof to seat base.</p>

Camera: 2



Description:

Front view centred to seat centreline, parallel to vehicle centreline.
Frame width: Outboard edge of A-pillar to far side B-pillar.
Frame height: Front edge of roof to seat base.

Camera: 3



Description:

Front view centred to yellow line, parallel to vehicle centreline.
Frame width: Outboard edge of A-pillar to far side B-pillar
Frame height: Front edge of roof to seat base.

Camera: 4



Description:

Front view centred to green line, parallel to vehicle centreline.
Frame width: Outboard edge of B-pillar to far side B-pillar.
Frame height: Front edge of roof to seat base.

Camera: 5



Description:

Side view of driver centred to middle of door aperture, door waist height.
Frame width: Facia to rear of seat back
Frame height: Head to pelvis.

Camera: 6



Description:

Frame width: Facia to rear of seat back

Frame height: Far side seat centreline to B-pillar.

Camera: 7

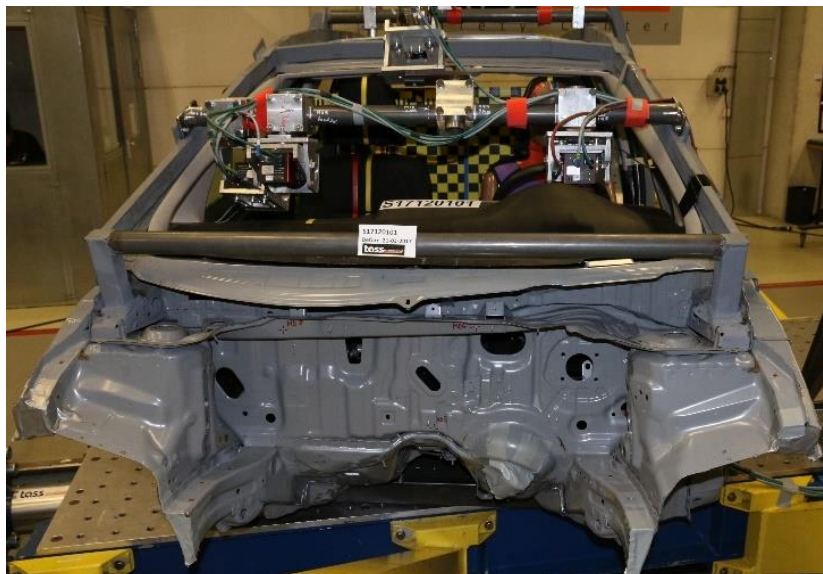

Description:

Front, parallel to vehicle centreline.

Frame width: Full width of BIW.

Frame height: Full height of BIW.

5.6 Still photography

5.6.1 Pre and post-test still photography is required to clearly show the sled set-up and BIW construction. Still photographs should show the fixings of the body in white to the sled, the steering column, facia/tunnel mounting and the appropriate body reinforcements before and after the series of tests.

No.	Pre	Post	View
1.	•	•	Top view of full BIW
2.	•	•	Front view of full BIW
3.	•	•	Rear view of full BIW
4.	•	•	Side view of full BIW
5.	•	•	Driver's side view of BIW at 45 ° to front
6.	•	•	Passenger's side view of BIW at 45 ° to front
7.	•	•	Side view of driver from outside
8.	•	•	Side view of driver from inside (including paint)
9.	•	•	Front view of driver
10.	•	•	Rear view of spacers in position
After dummy removal:			
11.		•	Paint transfer to centre console
12.		•	Paint transfer to passenger's side door/airbags (if applicable)

6 DATA PROCESSING AND REPORTING

6.1 Data processing

6.1.1 Data processing and assessment criteria calculation shall be supplied to ANCAP in ISO-MME format in accordance with Euro NCAP Technical Bulletin 021.

6.2 Reporting

6.2.1 The key deliverables will be as follows:

- Summary Dossier
- Reference pulse data in ISO MME format, as detailed in Section 4.1
- B-pillar accelerometer position details
- BIW & test set-up data, as detailed in Section 4
- H-point and head CoG measurement and comparison with full scale test
- Restraint system time to fire and comparison with full scale test
- All sensor outputs in ISO MME format
- All sensor curves plotted in a single PDF file (sled and ATD)
- High speed film (min. 1000fps) Section 5.5
- Photos, as detailed in Section 5.5
- All excursion line measurements relative to vehicle centreline (in Y axis)
- Details of peak intrusion measurement location and photograph
- Folder and file structure as follows:

/Vehicle/

 MDB/

 Channel/

 Document/

 Report/

 Movie/

 Photos/

 Pole/

 Channel/

 Document/

 Report/

 Movie/

 Photos/

 Reference pulses MDB/

 Channel/

 Document/

 Reference pulses Pole/

 Channel/

 Document/

7 FAR SIDE OCCUPANT ASSESSMENTS

7.1 Scoring

The points available for far side impact assessments in the final vehicle assessment is a total of 4 points, which will be combined with the full-scale MDB (2 points) and pole impact (2 points) scores. The far side score will be scaled down from the individual scores of the two far side sled tests, which offer a maximum of 12 points per test.

7.2 Head excursion

The peak head excursion in both sled tests will be established using the onboard cameras. The maximum amount of points available per body region in each test is dependent upon the amount of excursion observed and what specific far side impact countermeasures the vehicle is equipped with. Where the head excursion is outside the green zone, the number of points available for each body region will be reduced according to which zone the peak head excursion occurs, see Figure 5. A sliding scale is not applicable to head excursion.

7.2.1 Head excursion assessment zones

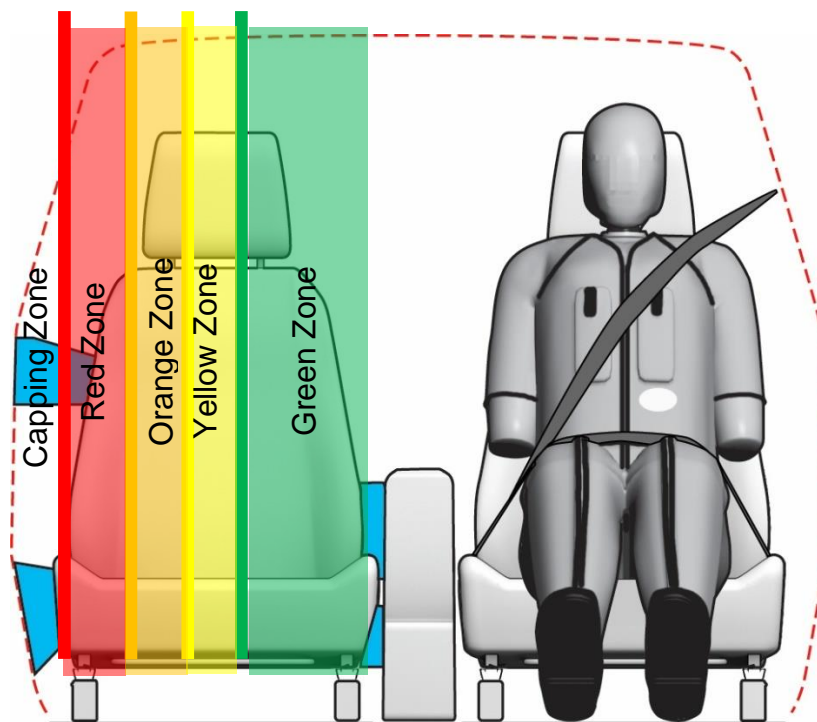

Figure 5: Head excursion zones

7.2.2 Scoring for vehicles with far side countermeasure

The maximum available points for each body region are dependent upon the amount of head excursion. The individual body region scores are presented in the table below.

Head Excursion						
	Capping Zone*	Red Zone**		Orange Zone	Yellow Zone	Green Zone
		≤125mm	>125mm			
Head Score	0.000	0.000	2.000	3.000	4.000	4.000
Neck Score	0.000	4.000	4.000	3.000	4.000	4.000
Chest Score	0.000	0.000	0.000	3.000	4.000	4.000
Max Dummy Score	0.000	4.000	6.000	9.000	12.000	12.000

* In case of head excursion in the Capping Zone, both far side tests are capped.

** With the head excursion in the Red Zone, the maximum head score is depending on whether the red excursion line is >125mm outboard of the orange excursion line or not. Where the head excursion is in the red zone, the vehicle is equipped with a countermeasure and the red excursion line is >125 mm outboard of the orange line, then the excursion shall be coloured brown instead of red.

7.2.3 Scoring for vehicles without far side countermeasure

The maximum available point for each body region is dependent upon the amount of head excursion. The individual body region scores are presented in the table below.

Head Excursion					
	Capping Zone*	Red Zone	Orange Zone	Yellow Zone	Green Zone
Head Score	0.000	0.000	1.000	2.000	4.000
Neck Score	0.000	1.000	1.000	2.000	4.000
Chest Score	0.000	0.000	1.000	2.000	4.000
Max Dummy Score	0.000	1.000	3.000	6.000	12.000

* In case of head excursion in the Capping Zone, both far side tests are capped.

7.3 Criteria and limit values

The basic assessment criteria used for both impact scenarios are summarised below. The assessments are divided into four individual body regions, the head, neck, chest & abdomen and pelvis & lumbar spine. Where multiple criteria exist for an individual body region, the lowest scoring parameter is used to determine the performance of that region.

For dummy injury criteria, a sliding scale system of points scoring has been used to calculate points for each measured criterion. This involves two limits for each parameter, a more demanding limit (higher performance), below which a maximum score, as listed in the tables above, is obtained and a less demanding limit (lower performance), beyond which no points are scored. Where a value falls between the two limits, the score is calculated by linear interpolation.

For both impact scenarios, capping is applied to the head, chest and abdomen. Where the dummy capping limit is exceeded, the score for the test in which this occurs will be 0 points.

7.3.1 Dummy criteria

	Criteria	Performance limits		
		Higher	Lower	Capping
Head	HIC ₁₅ (with direct contact)	500	700	700
	Resultant 3ms acceleration	72g	80g	80g
	*DAMAGE		[0.42]	
Upper Neck	Tension Fz		3.74kN	
	Lateral flexion MxOC	162Nm	248Nm	
	Extension negative MyOC		50Nm	
Lower Neck	Tension Fz		3.74kN	
	Lateral flexion Mx _(base of neck)	162Nm	248Nm	
	Extension neg. My _(base of neck)		100Nm	
Chest & Abdomen	Chest lateral compression	28mm	50mm	50mm
	Abdomen lateral compression	47mm	65mm	65mm

* Monitoring for 2024-2025.

A hard contact is assumed if the peak resultant head acceleration exceeds 80g or if there is other evidence of hard contact.

7.3.1.1 Monitoring criteria

7.4 Head rotational velocity measurement is required along with calculation of DAMAGE and reporting of the results is required in the spreadsheet. Modifiers

7.4.1 Pelvis and Lumbar loads

Limiting excursion by transmitting excessive loads through the pelvis and lumbar area may pose a risk of injury to occupants. A -4 point modifier is applied to the dummy score for each test in which any of the limits listed below are exceeded.

	Criteria	Performance limits	
Pelvis & Lumbar	Pubic symphysis	2.8kN	-4 points
	Lumbar Fy	2.0kN	
	Lumbar Fz	3.50kN	
	Lumbar Mx	120Nm	

7.4.2 Occupant to occupant protection

7.4.2.1 Where a vehicle is equipped with a far side countermeasure that is designed to limit head excursion but cannot provide meaningful head protection in occupant interaction (as defined in 7.3.3.2 below), the final far side score (max 4 points) will be reduced by 1 point.

7.4.2.2 Where a vehicle is equipped with a countermeasure that is specifically designed to provide additional protection from occupant interaction, its efficacy will need to be demonstrated in the official ANCAP pole impact test with the use of two mid-sized WorldSID dummies.

a) Where the OEM can show that the presence of the passenger in the dual occupancy pole test will influence the results of the nearside driver, the OEM may sponsor an additional single occupant pole test. The results will instead be used to rate the near-side pole impact performance.

More details of the dual occupancy test are provided in the ANCAP Oblique Pole Impact Testing Protocol.

Where, in the dual occupancy test, there is interaction between either dummy head and the adjacent occupant (7.4.2.3) and/or the protection offered is not symmetric (7.4.2.4), and/or the protection zone is not met (7.4.2.5), the final far side score (max 4 points) will be reduced by 1 point.

7.4.2.3 The heads of both the driver and passenger dummies will be evaluated. Upper neck and shoulder forces for both dummies must be reported. Interaction will be determined from the high-speed film with either evidence of direct contact or where the head lower performance limits (HIC & 3ms) are exceeded. Any direct contact between the far side occupant's head and any part of the nearside occupant will be assessed regardless of whether the limits in 7.3.1 have been exceeded or not. For example, if an inflatable countermeasure allows the far side occupant's head to contact the driver, the peak resultant acceleration trace and/or the high-speed film will be used to identify head contact.

7.4.2.4 Countermeasures must offer equivalent levels of protection in dual occupancy scenarios regardless of which side of the vehicle is impacted. Where a countermeasure is asymmetric, the OEM must provide evidence to show that it provides protection when impacted on both sides. For example, with a second dual occupancy test impacting the passenger side of the vehicle or numerical simulations. Both seats shall be set to that of the MDB test.

7.4.2.5 A countermeasure against occupant interaction must be able to protect a range of occupant sizes in different seating positions. Regardless of which dual occupancy test is performed, the coverage zone must be demonstrated in the zone defined as follows: Protection must be provided in a rounded rectangular area between the

passenger head CoG in the dual occupancy pole test position and forwards up to the driver pole impact test position plus an additional 82mm border front and rear (half head diameter). In the vertical direction, the zone is 120mm upwards and downwards of the CoG (Figure 6). The following shall be noted:

- a) Where countermeasures utilise inflatable systems, the protection zone is measured on a flattened countermeasure using the passenger's head paint mark on the countermeasure from the dual occupancy pole impact test. This will be evaluated during the vehicle inspection. Where the MDB test is used to show occupant to occupant protection, additional data is required to establish the location of the passenger's head CoG when in the rearmost seating position.
- b) It may be necessary to measure the coverage area using an inflated airbag. For example, using a flattened airbag may not be suitable if the shape/orientation of the inflated area cannot be flattened. This will be evaluated during the vehicle inspection.
- c) In some cases, the countermeasure may offer protection in the requested zone without fully or partially covering the protection zone. In this case, the robustness of occupant to occupant interaction avoidance in the requested protection zone must be clearly demonstrated to ANCAP by the manufacturer. This must be done with in house, full scale test data from an equivalent occupant to occupant pole test where the passenger seat is in the same position as that of the driver. A different test set-up may be necessary to show that the systems works for different statures within the protection zone, e.g. a higher or lower seat position.

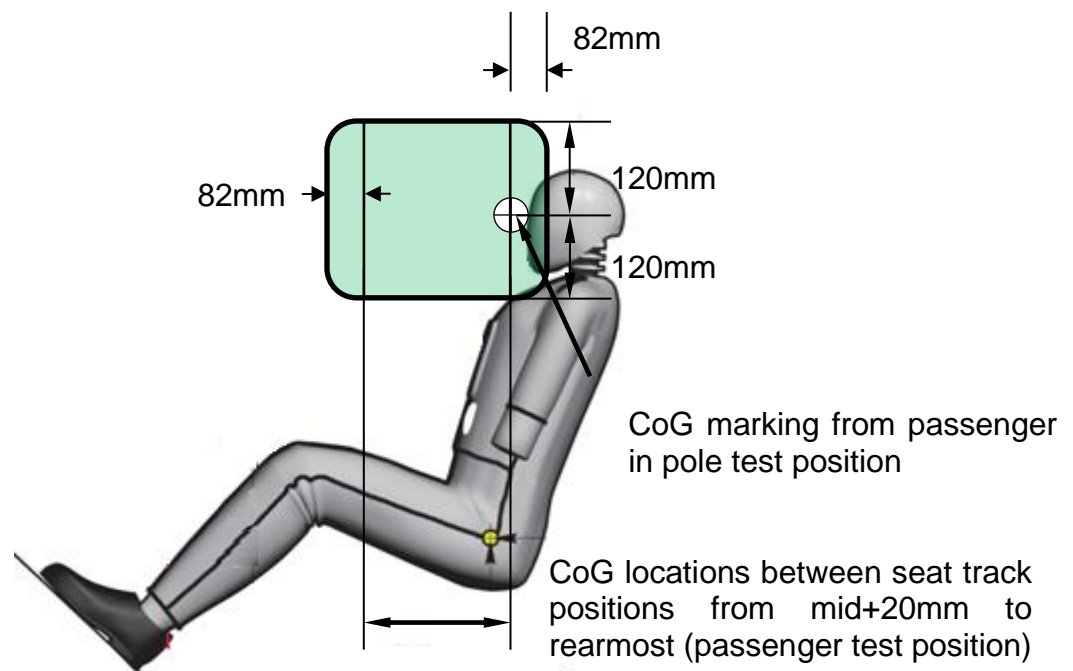

Figure 6: Protection zone

Appendix I

To determine the excursion lines the following method is to be followed. In this method the following definitions are used:

Intrusion area

The intrusion area is the external area limited by the following lines:

Line	Description
A	Vertical line at x-position 700mm forward of the R-point
B	Horizontal line at z-position of R-point
C	Vertical line at x-position at the back of headrest stems
D	Door waist line

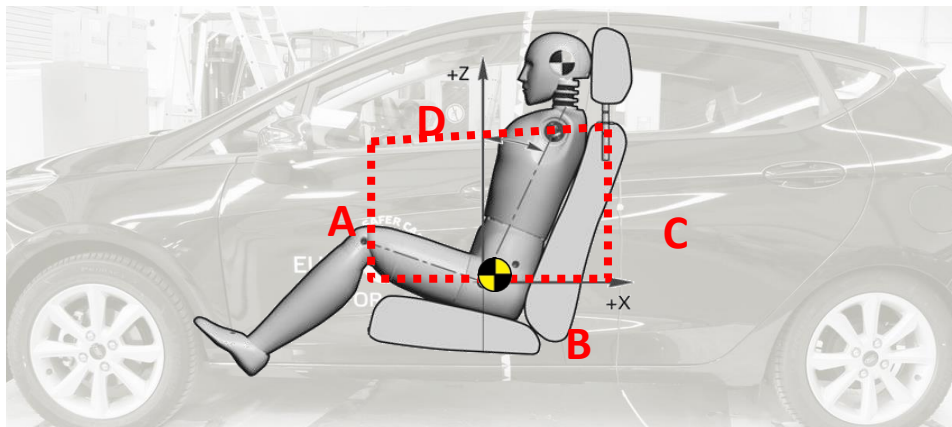

Maximum inboard intrusion

The maximum inboard point is determined within the intrusion area, the method to find this point is described as follows. There is no compulsory procedure how to measure the maximum inboard point. It is acceptable to use 3D scan, 3D arm or a tape measure.

In most cases the armrest will be the most inboard part. Therefore, the measurement will be taken from the most inboard surface of the armrest.

At waistline level, if this is the most inboard area, the inner door trim/cover is ignored. The point is defined as the most inboard metal part of the door structure +50mm inboard (see example below).



Appendix II

The pulse performed on the sled facility should be close to or more severe as the pulse defined in Section 4.1.3, $A_{x \text{ sled}}$. All references to 'sled pulse' refer to the acceleration measured at the B-pillar on the body-in-white. To validate this point, the following process should be used:

- Change the orientation to have body-in-white B-pillar pulse and vehicle pulse in globally positive values
- Calculate by integration the Delta V ($DV1(t)$) from vehicle pulse, setting the initial velocity to 0
- Calculate by integration the Delta V ($DV2(t)$) from sled test, setting the initial velocity to 0
- Calculate the difference $DV(t) = DV1(t) - DV2(t)$
- Calculate by integration of $DV1(t)$ the X displacement $DX1(t)$ from vehicle, setting the initial value to 0
- Calculate by integration of $DV2(t)$ the X displacement from sled test (BIW), setting the initial value to 0
- Calculate the difference $DX(t) = DX1(t) - DX2(t)$
- Calculate DX at 120 ms

Requirement #1:

- If all the $DV(t)$ values up to 120 ms are in the zone as shown below, requirement #1 is OK – check requirement #2
- If some $DV(t)$ values up to 120 ms are outside the zone, requirement #1 is not OK
 - **sled test (BIW) is less severe than the vehicle test pulse and cannot be accepted**

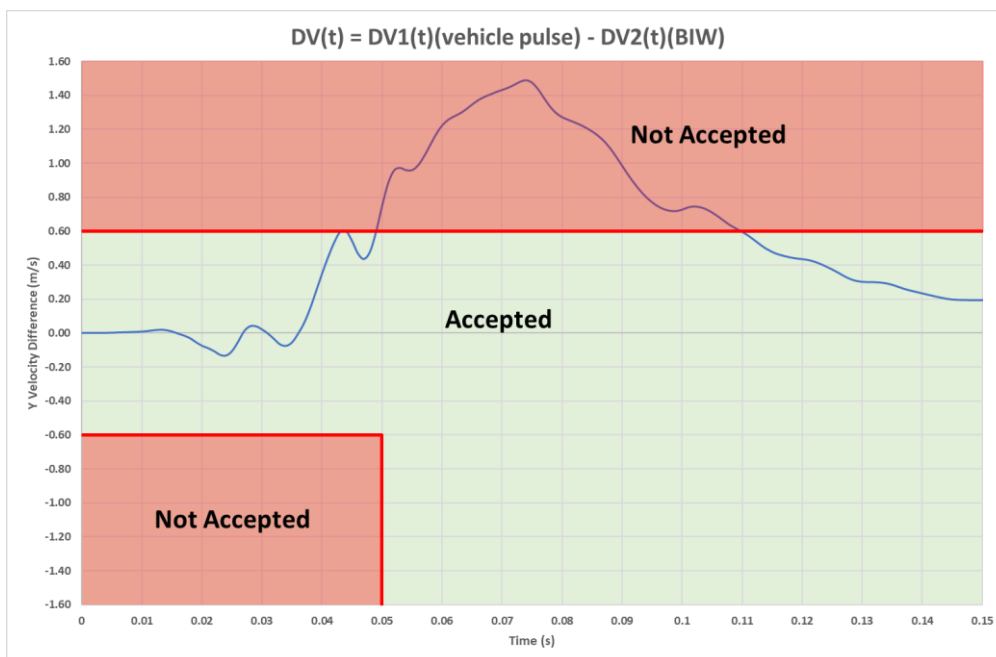

Sample pulse showing a sled test that cannot be accepted as parts of DV are outside the acceptable zone

- **sled test (BIW) is more severe than the vehicle test pulse in the early phase and cannot be accepted**

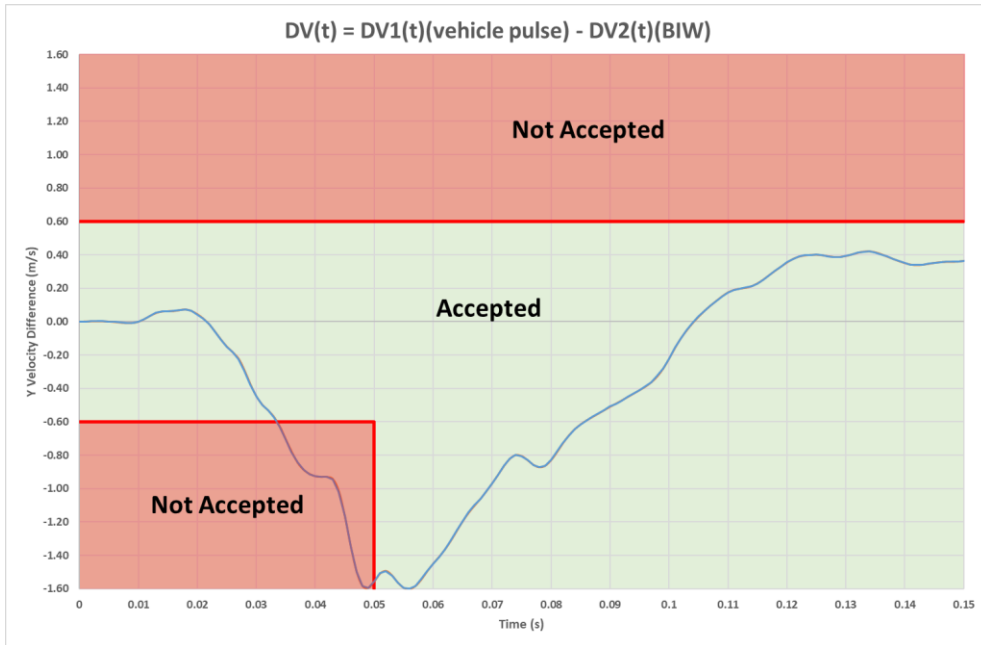

Requirement #2:

- If DX value at 120 ms is negative, requirement #2 is OK
→ **sled test is accepted**
- If DX value at 120 ms is positive, requirement #2 is not OK
→ **sled test cannot be accepted**

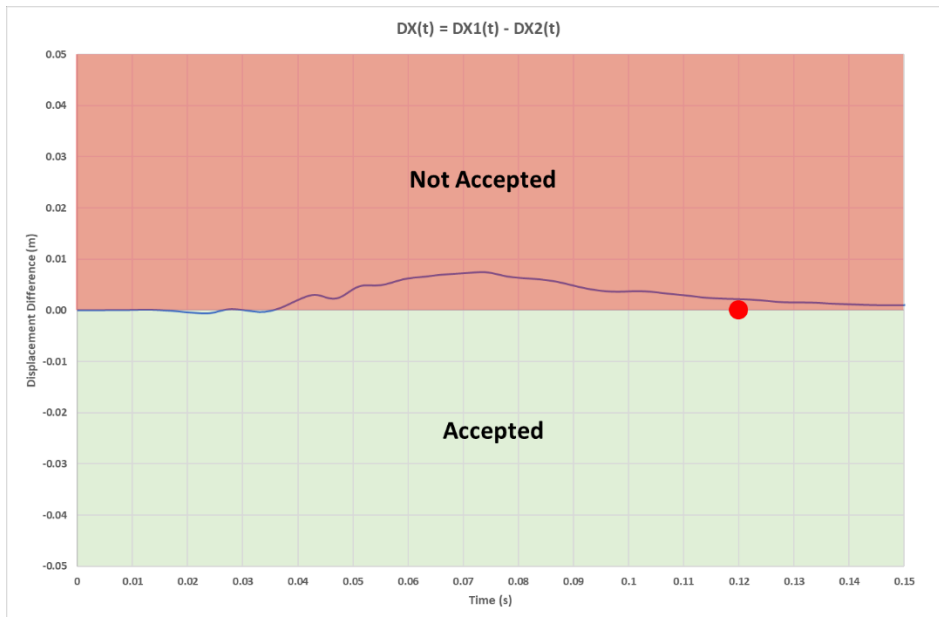

Appendix III

Seat mounted arm rests

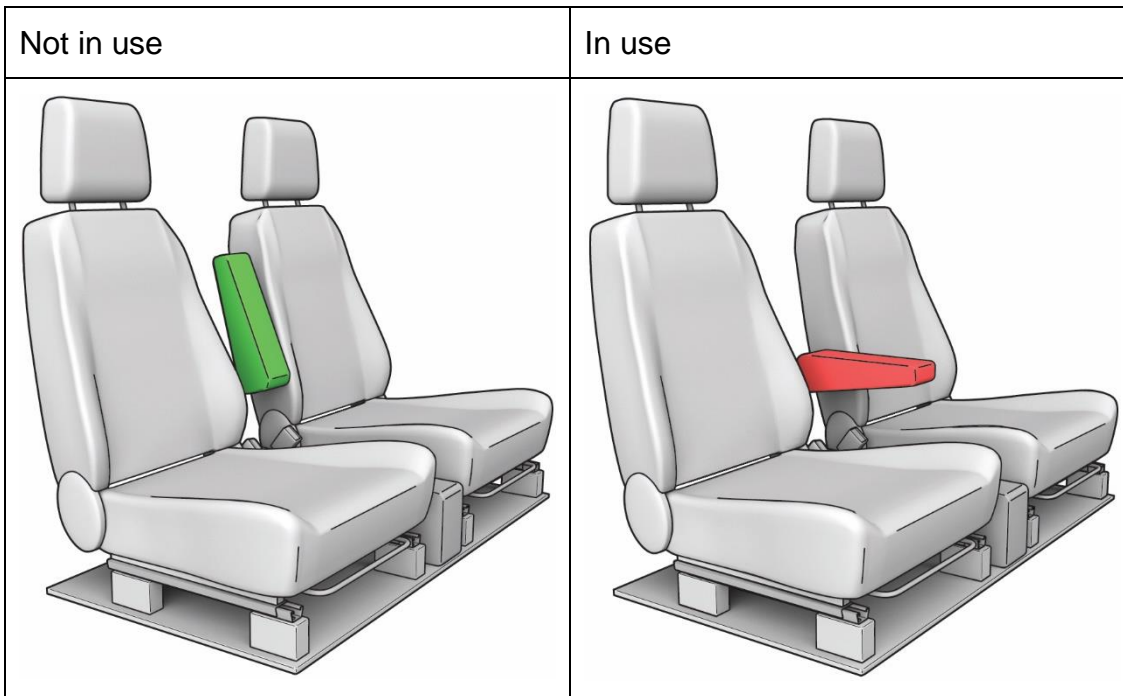

Centre console and tunnel mounted

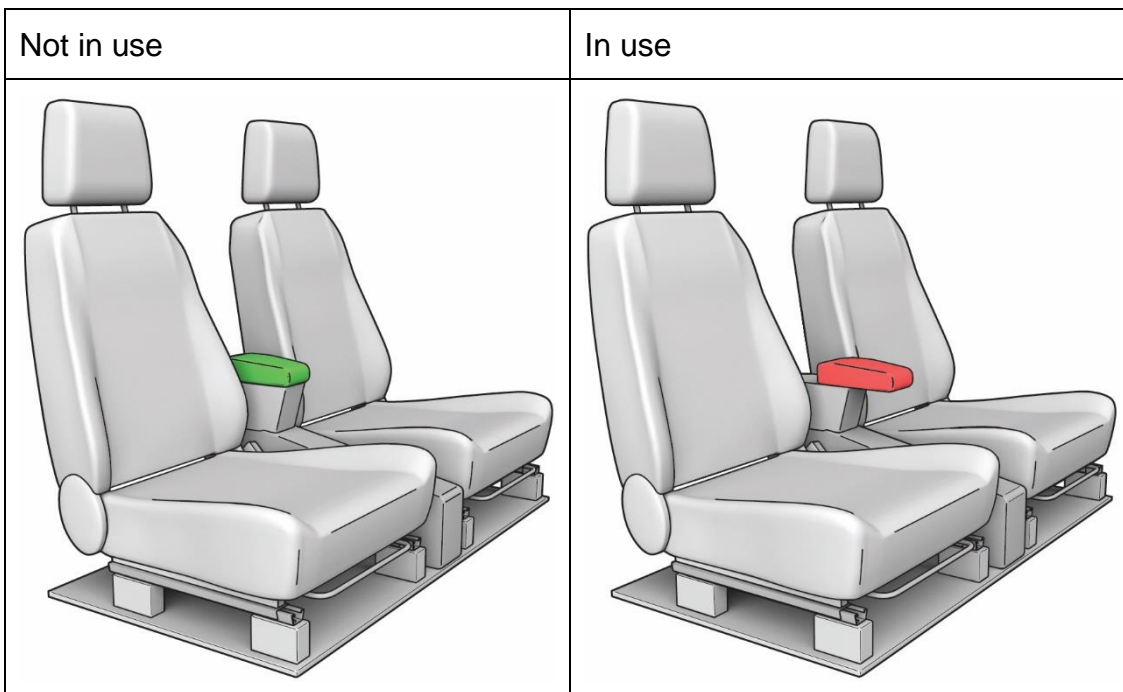

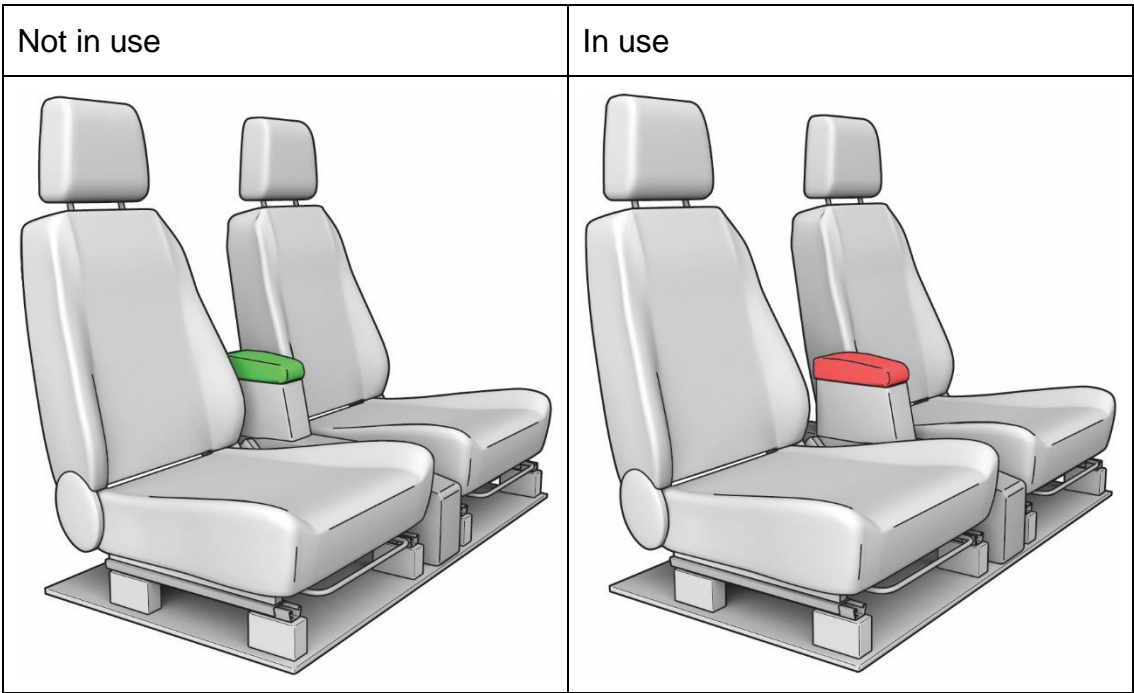
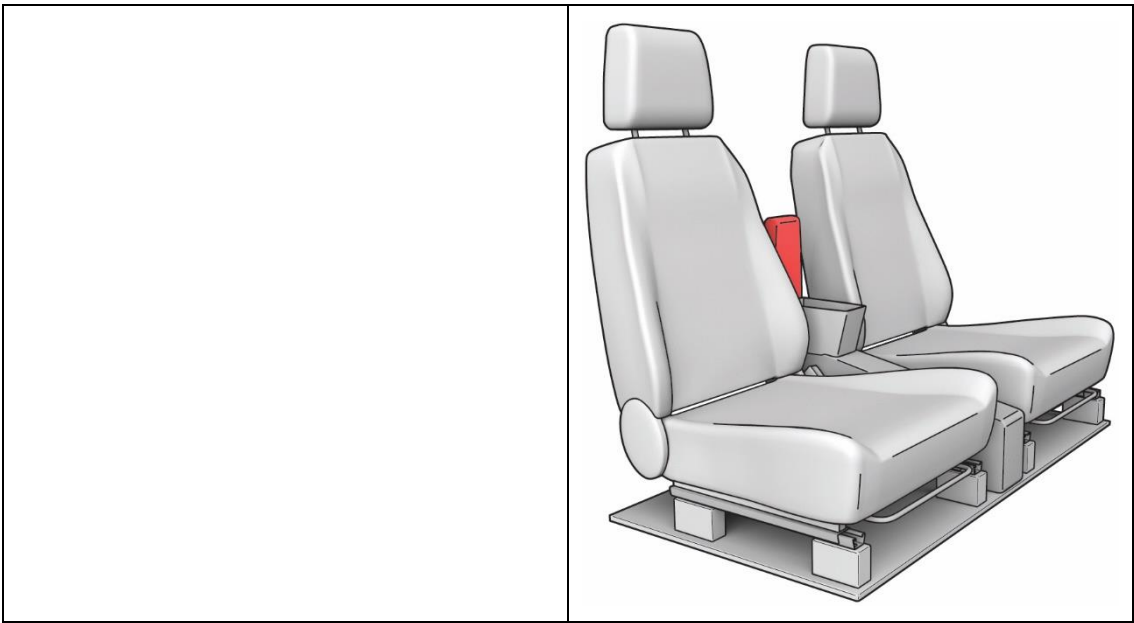

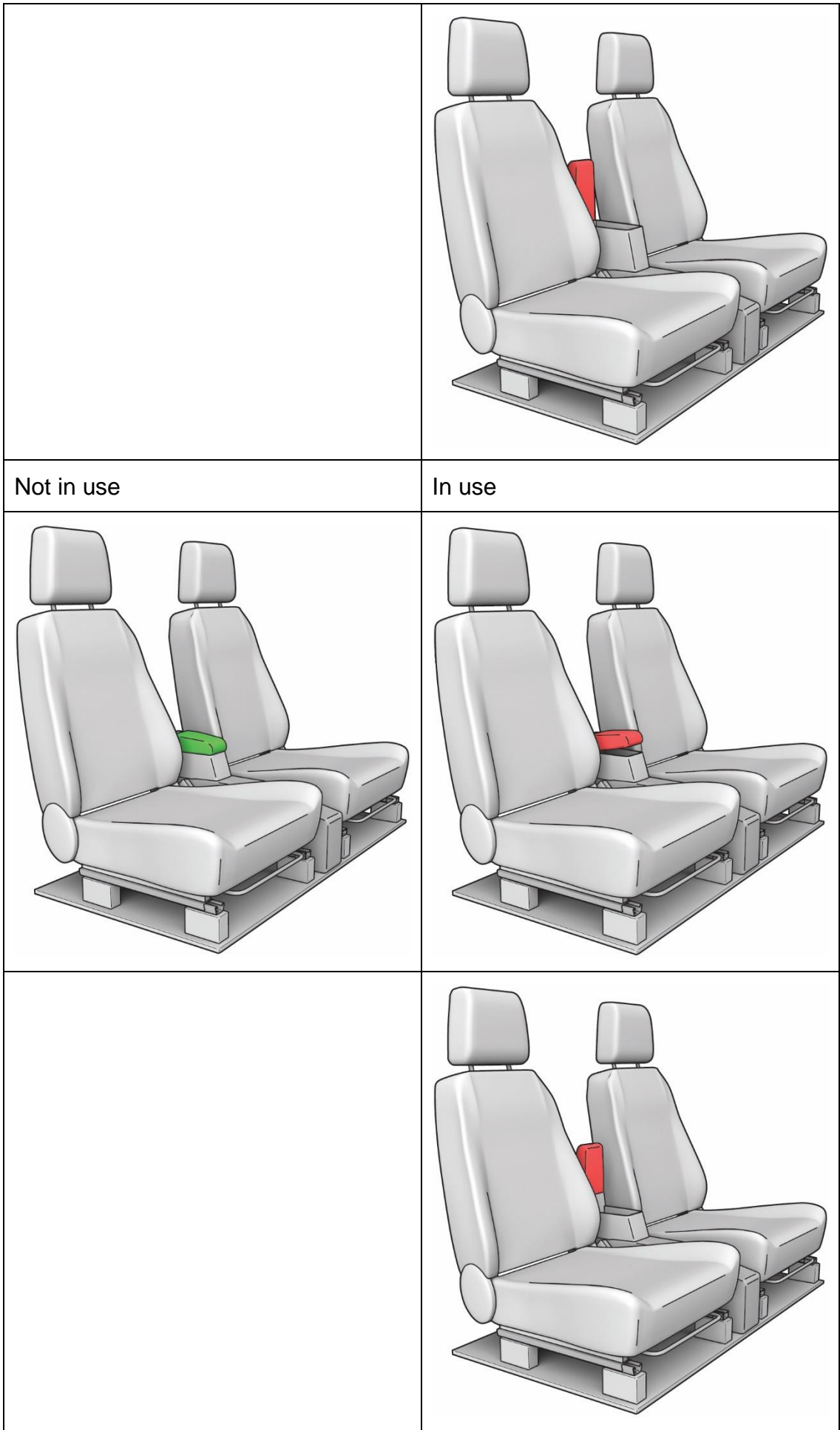

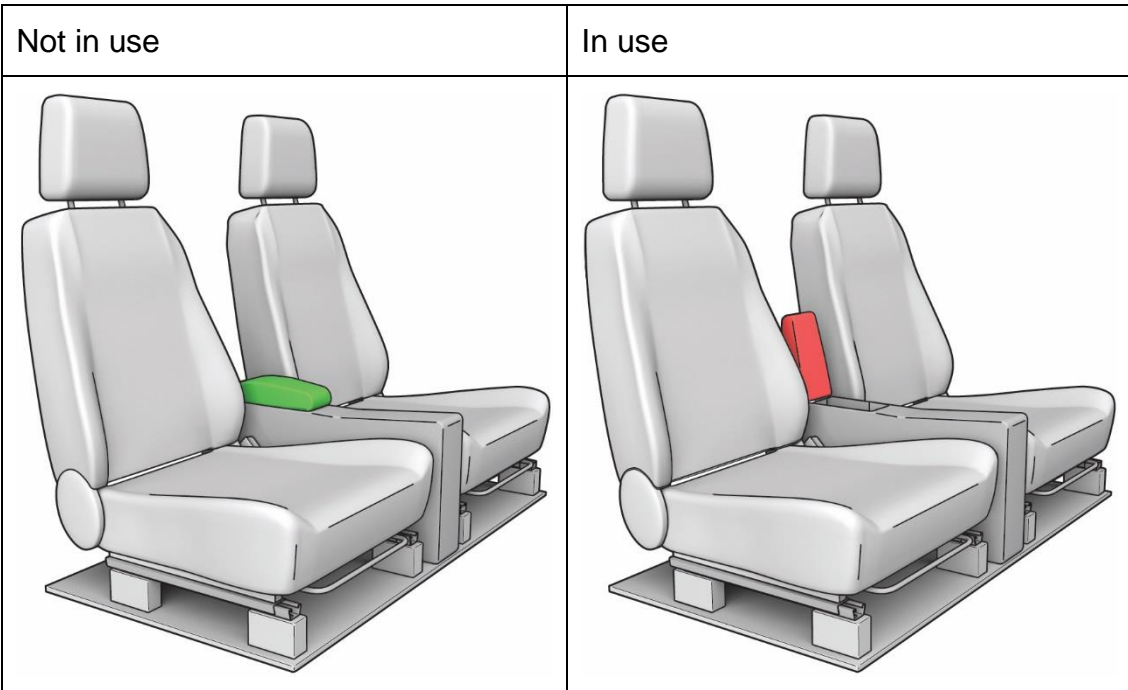
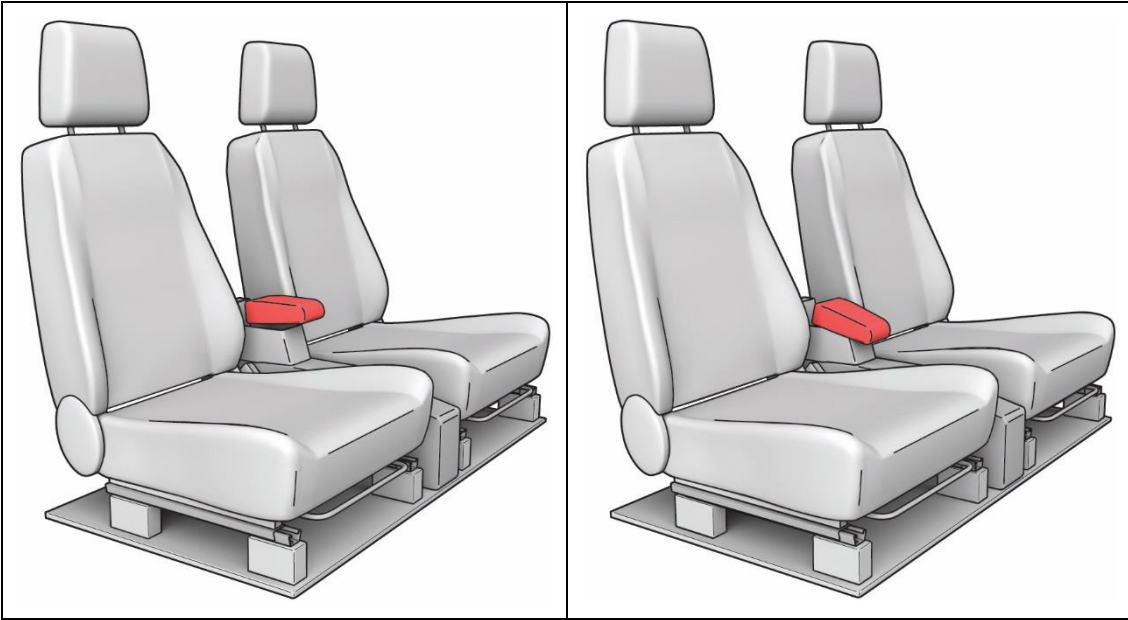

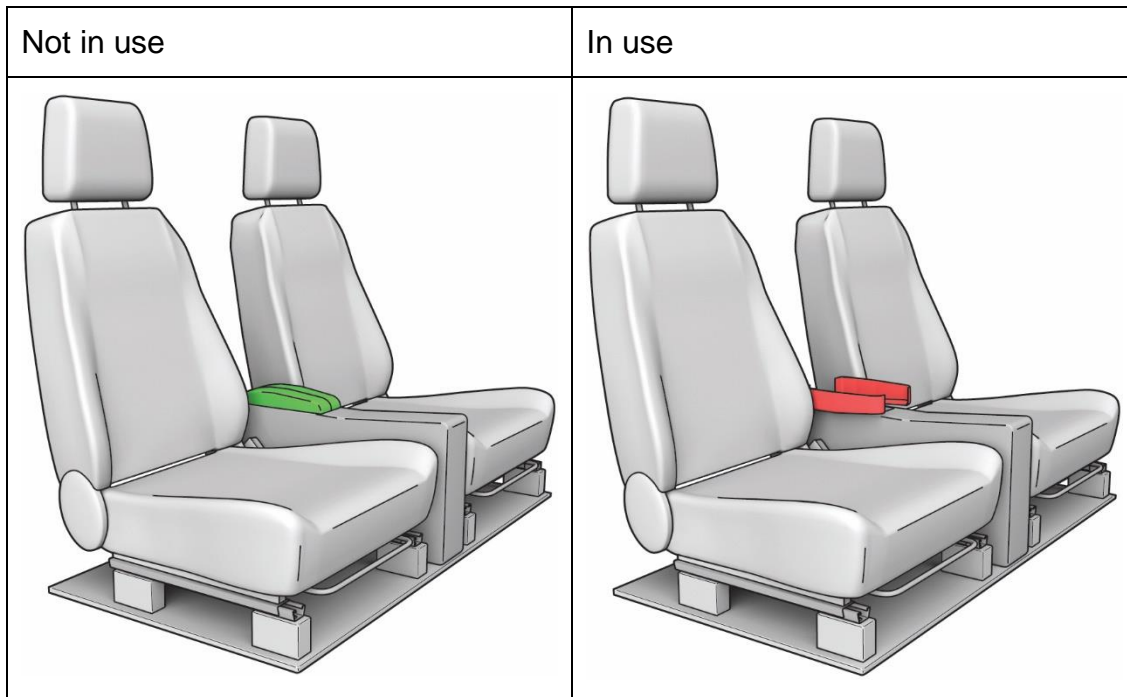



Appendix IV

Location	Parameter	Axis	ISO Code
Head CoG	Angular velocities	x	1?HEAD0000WSAVX0
		y	1?HEAD0000WSAVY0
		z	1?HEAD0000WSAVZ0
	Accelerations	x	1?HEAD0000WSACX0
		y	1?HEAD0000WSACY0
		z	1?HEAD0000WSACZ0
Upper neck	Forces	x	1?NECKUP000WSFOX0
		y	1?NECKUP000WSFOY0
		z	1?NECKUP000WSFOZ0
	Moments	x	1?NECKUP000WSMOX0
		y	1?NECKUP000WSMOY0
		z	1?NECKUP000WSMOZ0
Lower neck	Forces	x	1?NECKLO000WSFOX0
		y	1?NECKLO000WSFOY0
		z	1?NECKLO000WSFOZ0
	Moments	x	1?NECKUP000WSMOX0
		y	1?NECKUP000WSMOY0
		z	1?NECKUP000WSMOY0
Spine – T4	Accelerations	x	1?THSP0400WSACX0
		y	1?THSP0400WSACY0
		z	1?THSP0400WSACZ0
Spine – T12	Accelerations	x	1?THSP1200WSACX0
		y	1?THSP1200WSACY0
		z	1?THSP1200WSACZ0
Lumbar spine	Forces	x	1?LUSP0000WSFOX0
		y	1?LUSP0000WSFOY0
		z	1?LUSP0000WSFOZ0
	Moments	x	1?LUSP0000WSMOX0
		y	1?LUSP0000WSMOY0
		z	1?LUSP0000WSMOZ0
Shoulder joint	Forces	x	1?SHLD??00WSFOX0
		y	1?SHLD??00WSFOY0
		z	1?SHLD??00WSFOZ0
Shoulder – rib	Displacement	1D	1?SHRI??00WSDC00
	Angular displacement		1?SHRI??00WSAN00
Thorax - Upper rib	Displacement	1D	1?TRRI??01WSDC00
	Angular displacement		1?TRRI??01WSAN00
Thorax - Mid rib	Displacement	1D	1?TRRI??02WSDC00
	Angular displacement		1?TRRI??02WSAN00
Thorax - Lower rib	Displacement	1D	1?TRRI??03WSDC00
	Angular displacement		1?TRRI??03WSAN00
Abdomen – Upper rib	Displacement	1D	1?ABRI??01WSDC00
	Angular displacement		1?ABRI??01WSAN00
Abdomen – Lower rib	Displacement	1D	1?ABRI??02WSDC00
	Angular displacement		1?ABRI??02WSAN00
Pelvis	Accelerations	x	1?PELV000000ACX0
		y	1?PELV000000ACY0
		z	1?PELV000000ACZ0
Pubic Symphysis	Force	y	1?PUBC0000WSFOY0
B-Pillar (non-struck side)	Accelerations	x	1?BPILLO0000ACX0
		y	1?BPILLO0000ACX0
		z	1?BPILLO0000ACX0
Lap Belt (B6)	Force	1D	1?SEBE0003B6FO00
Shoulder Belt (B3)	Force	1D	1?SEBE0003B3FO00

CALCULATED CHANNELS			
Shoulder – rib	Displacement corrected		1?SHRI??00WSDS00
Thorax - Upper rib	Displacement corrected		1?TRRI??01WSDS00
Thorax - Mid rib	Displacement corrected		1?TRRI??02WSDS00
Thorax - Lower rib	Displacement corrected		1?TRRI??03WSDS00
Abdomen – Upper rib	Displacement corrected		1?ABRI??01WSDS00
Abdomen – Lower rib	Displacement corrected		1?ABRI??02WSDS00
B-Pillar (non-struck side)	Calculated global velocities	x	1?BPILLO0000VEX0
		y	1?BPILLO0000VEY0
		z	1?BPILLO0000VEZ0
<i>Total number of required channels:</i>			63

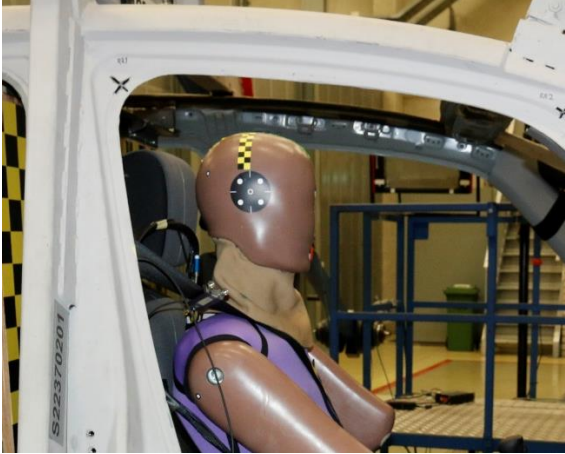
Appendix V

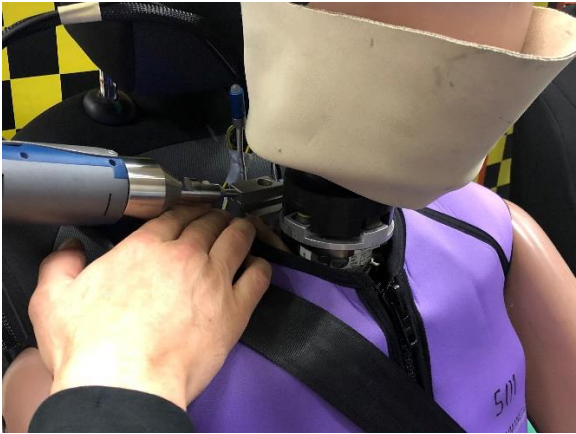
Description	
<p>Head CoG, Outboard head skin marking</p>	
<p>Neck bracket, rearmost, outboard corner of the bracket</p>	
<p>Neck bracket, foremost, outboard corner of bracket</p>	

Outboard arm, shoulder screw centre

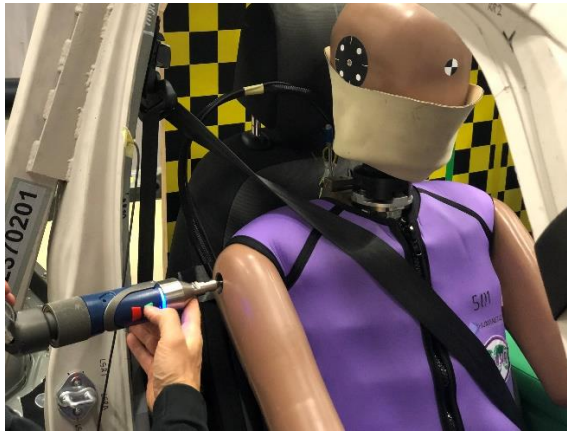

Outboard arm, tip of arm foam centre



Outboard arm angle, place a straight edge along the length of the arm



Outboard femur,
centreline of knee clevis

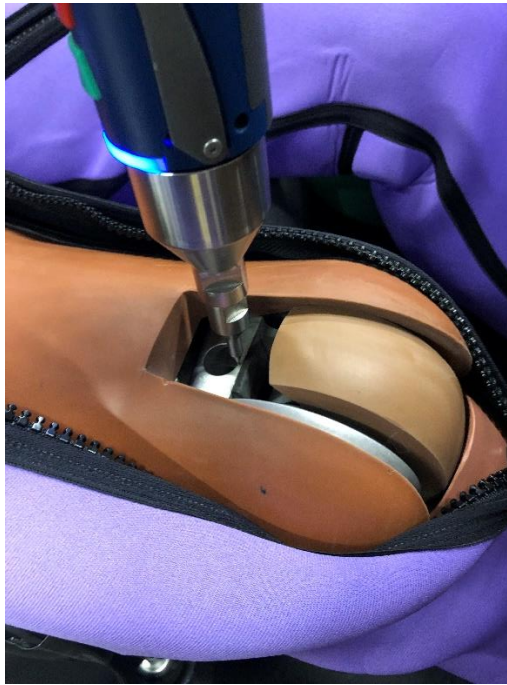

Outboard knee, knee
joint/bolt centre

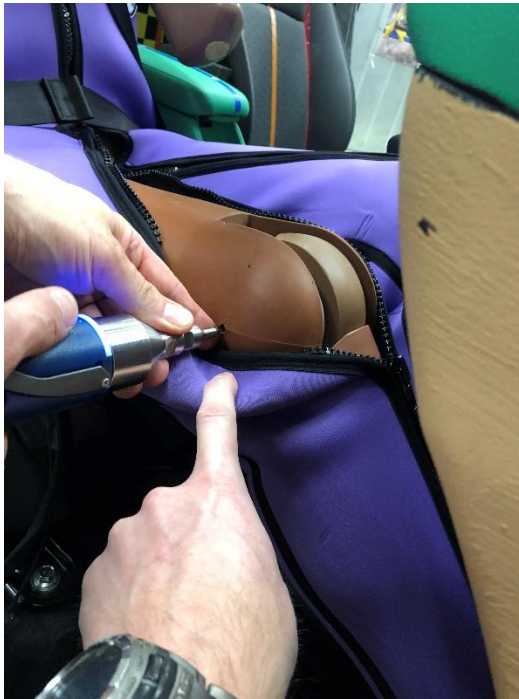

Outboard femur, angle, place a short length inclinometer on the femur centreline



Outboard ankle, centre of bolt



Outboard head restraint tube, most outboard part of the tube where it meets the seatback.



Diagonal seatbelt

